

Rogowski Coil



www.mbs-ag.com



FASK - Flexible current sensors for primary currents up to 100 kA

Technical principles

As well as conventional current transformers, also Rogowski coils can be used for measuring current. The absence of an iron core means that no non-linear effects arise. Rogowski coils are easy to attach and remove without disconnecting the power circuit, i.e. without significant assembly work.

In contrast to current transformers, high short-circuit currents in energy distribution do not cause high forces or losses when Rogowski coils are used. In addition, no residual magnetic or saturation effects detrimental to measurement can arise, unlike those occurring in normal current transformers and requiring laborious demagnetisation.

Equally, no dangerous voltages can be generated in open operation, and so this causes no risk to electricians.

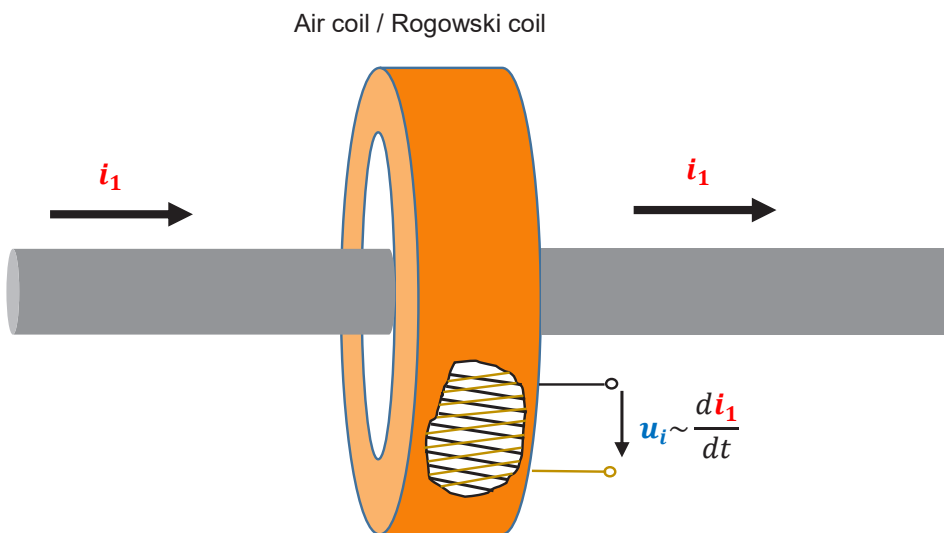

Figure 1: Rogowski coil with primary conductor

As can be seen in the figure, the output signal of the passive Rogowski coil is a voltage signal which is proportional to the change in the primary current. If the primary current is a 50 Hz sinusoidal signal, as is usual for electrical energy distribution in Europe, then the following expression results.

$$i_1 = \hat{i}_1 \times \sin(2\pi f \times t)$$

In order now to determine the slope of the tangents at point t , function i_1 with respect to t is derived. The following equation results:

$$\frac{di_1}{dt} = 2\pi f \times \hat{i}_1 \times \cos(2\pi f \times t).$$

Accordingly, the output voltage of the Rogowski coil is proportional to the derivation of i_1 with respect to time. Because the cosine function is displaced by -90° with respect to the sine function, the voltage signal u_i is similarly displaced by -90° with respect to the primary current i_1 .

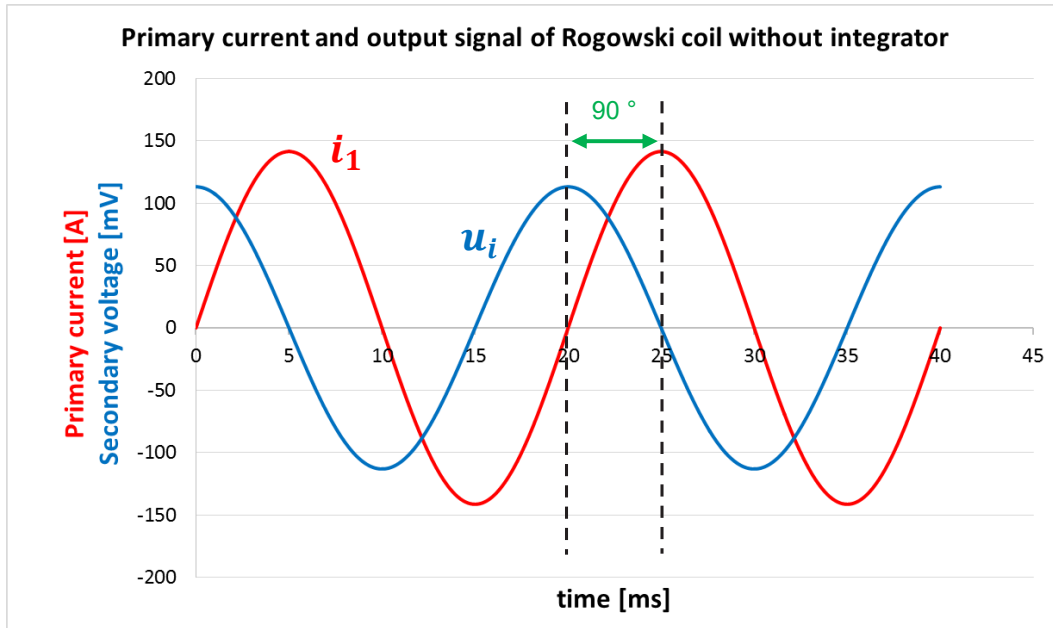

Figure 2: Comparison of primary current and output signal of a passive Rogowski coil

If the Rogowski coil is now matched (at 50 Hz) to the current signal to be measured, then by taking into account the transmission factor and the phase shift of -90° , it is possible to calculate back to the current i_1 . If the signal's rated frequency now changes, then the amplitude value is affected by u_1 as well.

$$u_i \sim \frac{di_1}{dt} = 2\pi f \times \hat{i}_1 \times \cos(2\pi f \times t)$$

These effects can be nullified in an electronic integrator circuit. Here, from a mathematical point of view, the derivation is integrated with respect to t . The cosine function becomes the sine function again, and the phase shift of 90 degrees is nullified. Using an integrator which provides a current signal as an output, the following equivalent circuit results.

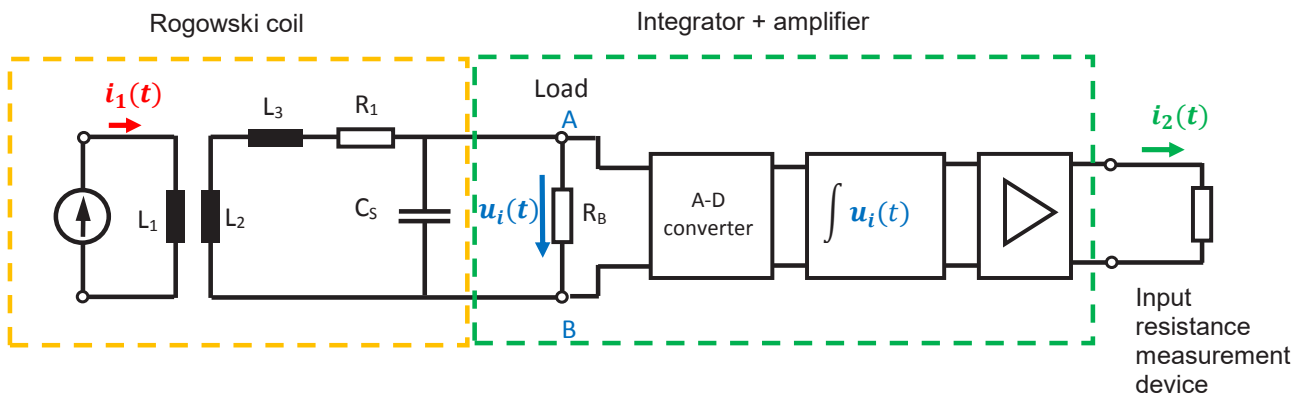

Figure 3: Electrical equivalent circuit for Rogowski coil + 1 A integrator

The Rogowski coil FASK

The MBS Rogowski model FASK are supplied in four different diameters (100, 150, 200 and 300 mm). An insertion point is provided on the closure; this is for a cable tie to attach the coil to the primary conductor.



Figure 4: The Rogowski coil FASK 100

General attributes

In order to achieve the maximum accuracy possible when measuring using Rogowski coils, the following items must be noted:

- In order to avoid parasitic effects, the Rogowski coil, including the supply cable, must be completely shielded.
- The output voltage of Rogowski coils is usually specified in mV/kA. Because voltage signals are generally deemed to be relatively failure-prone, the coil on the output should generate as large a voltage signal as possible because when smaller primary currents flow the output signal can be affected by noise or interference signals, and so the stated accuracy classes can no longer be achieved.
- The position of the primary conductor often affects the accuracy. When installing, it should be ensured that the coil is fitted so as to achieve the best accuracy.

Benefits of the Rogowski coil FASK

- The Rogowski coils FASK 100, 150, 200 and 300 are completely shielded, and are therefore extensively protected from interference effects.
- All Rogowski coils generate a relatively large output signal of 100 mV/kA. Because of the coil's good linearity, even relatively small primary currents well below 1 kA can be measured accurately.
- The Rogowski FASK coils have a phase error between -0.4 and -0.5 degrees, and so a fixed correction factor can be used in the measurement device.
- The materials permit use in very aggressive ambient temperatures. The coils generate no waste heat.
- The supply cable can be shortened without loss of accuracy.

As with any Rogowski coil, the positioning of the primary conductor affects the accuracy. The FASK series is designed so that the smallest error arises directly at the closure, i.e. in the attachment area. The following figure clarifies this situation and defines the exact error values.



Position of primary conductor	Typical error [%]
Directly at the closure	< 0.5
From mid-point to outer edges of coil	< 0.8
Directly opposite the closure	< 1.0

Figure 5: Position of primary conductor, with typical error values

Installation

These sensors are extremely easy to install. Just a few simple steps are required to position the coil around the primary conductor and to connect it to the closure. The primary conductor does not need to be disconnected.

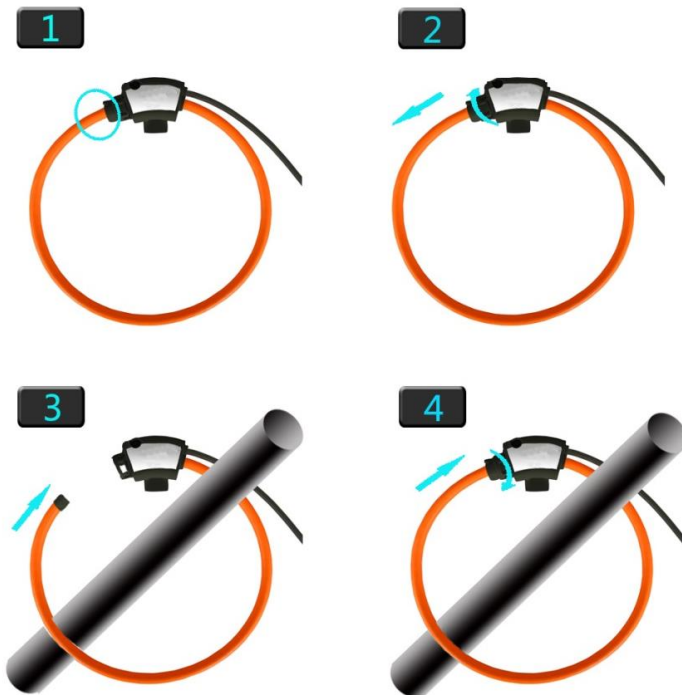

Figure 6: Installation of the FASK

Materials used

Model	FASK 100, 150, 200 and 300
Coil & cable	Thermoplastic rubber Low flammability as per UL 94 V-0
Closure	As per PA6 UL 94 V-0
Colour (coil)	Orange
Shielding	100% coil and 100% supply cable

Safety

Model	FASK 100, 150, 200 and 300
Certifications	CE certified
	Complies with EMC EN 61326-1:2006
	IP 68
Insulation voltage	Coil: 3000V
	Supply cable: 1000V
Safety	1000V CATIII; 600V CATIV

Technical parameters

Model	FASK-100	FASK-150	FASK-200	FASK-300
Coil length	395 mm	525 mm	665 mm	965 mm
Coil window size	100 mm	150 mm	200 mm	300 mm
Weight	approx. 100 to 160 g			
Transmission	100 mV/kA @ 50 Hz			
Transmission error	< 0.5 % at the central position of the closure @ 25 °C			
Phase error	≤ 0.5 ° (30 angular minutes)			
Maximum measurable current	100 kA			
Coil resistance	is between 100 and 250 Ohm			
Coil diameter	8 mm			
Supply cable length	3 m / 5 m	3 m	3 m	3 m
Temperature coefficient	400 ppm/K			
Position error	± 1 % maximum			
Linearity error	± 0.2 % maximum of the measured value			
Bandwidth	1 Hz to 100 kHz (- 3dB)			
Working temperature range	-30 to +80 °C			
Storage temperature range	-40 to +90 °C			

Subject to technical modifications

Please note that the details given above are standard values. Values which differ are available upon request.

Dimensions

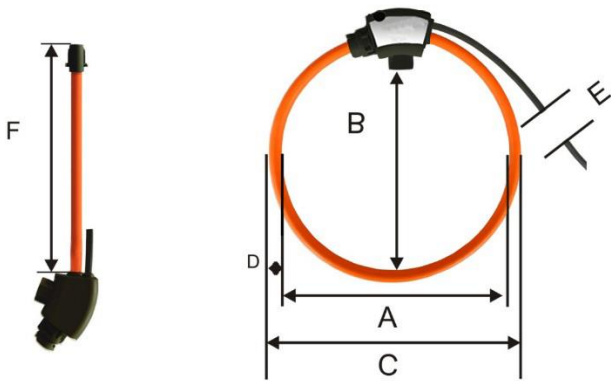

Designation	Description	FASK-100	FASK-150	FASK-200	FASK-300
A	Window size A [mm]	135	165	210	310
B	Window size B [mm]	100	150	200	300
C	External diameter of coil [mm]	151	181	226	326
D	Coil diameter [mm]	8			
E	Length of supply cable [m]	3 / 5 / 10	3 / 10	3 / 10	3 / 10
F	Coil length [mm]	395	525	665	965

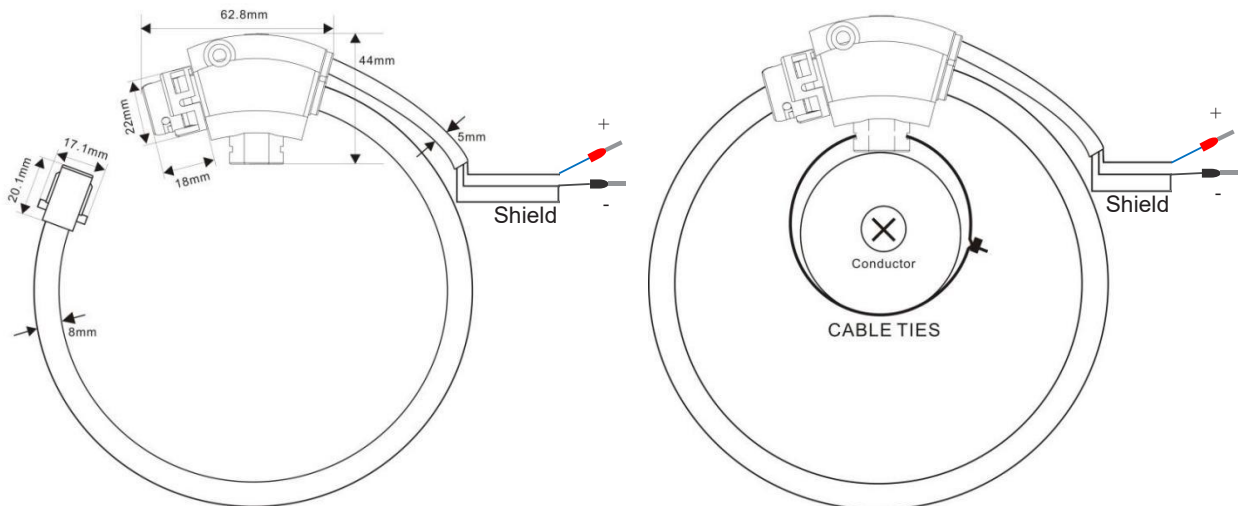

Figure 7: Further dimensions of FASK 100, 150, 200 and 300

The ROI-3 integrator

In order to correct the phasing of the passive Rogowski coil by 90°, an integrator circuit is necessary. At the same time it is desirable to maintain a standard signal, in order to ensure compatibility with the usual measurement devices. The three-phase ROI-3 integrator is ideally suited to an output of 1 A. Three Rogowski coils can be connected simultaneously. A 24V DC source is required as the voltage supply. Installation on a 35 mm-DIN-rail is intended.



The output signal (1A) must be connected exclusively with potential-separated 1A current transformer inputs.



It is prohibited to connect the input or output signal with external voltage. This can lead to the destruction of the ROI-3 measurement transducer.

Figure 8: Three-phase ROI-3 integrator

How the ROI-3 works

- An integrator is essential in order to balance the output signal of the Rogowski coils and to shift it by 90°. The integrator consists of an active electronic circuit with negligible offset and good linearity.
- The output voltage signal of the Rogowski coil is converted to the 1 A standard signal.
- The output voltage signal of the passive Rogowski coil is proportional to the frequency of the measured current. The installed equaliser guarantees a signal which is linear to the primary current over a wide frequency range.
- When ordering in connection with the Rogowski coil FASK, the primary rated current must be specified. A fixed transmission ratio results, as for a standard current transformer (e.g. 1,000/1 A). The primary measurement range 0 to 1000 A is mapped to the secondary measurement range of 0 to 1 A.

Benefits of the ROI-3

- Compact casing for the connection of three FASKs
- The ROI-3 does not measure direct currents when used with the FASK; however, in contrast to a conventional current transformer it can perform exact measurements of the alternating current component, even if a large superimposed direct current component is present, because there is no iron core to cause saturation. This function is particularly important for the measurement of ripple currents, e.g. in battery charging systems.
- The ROI-3 integrator has relatively good frequency behaviour.

Terminal assignment

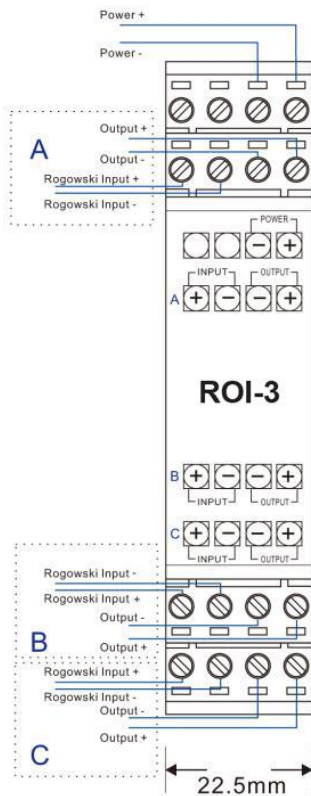

Figure 10: Wiring diagram for ROI-3

Specifications

Model	ROI-3
Number of phase connections	3
Rated output signal	1A AC rms
Max. output signal (overload)	1.5A AC rms
Primary rated currents [A]	250; 400; 630; 1,000; 1,500; 2,000; 4,000; 6,000; 10,000
Transmission accuracy	0.5% at 1% (≥ 10 A) to 110% of the primary rated current @ 25 °C
Phase error	$\leq 0.5^\circ$
Linearity	$\pm 0.2\%$ of the measured value (at 10 to 120% of the rated current)
Bandwidth	30 Hz to 5 kHz
Maximum load per phase	0.5 Ω
Energy consumption	10 W
Output at 0 A (zero drift)	≤ 0.01 A
Temperature drift	200 ppm/K
Weight	185 g
Dimensions	114 x 100 x 22.5 mm
Supply voltage	24V DC
Working temperature range	-30 °C to +70 °C
Storage temperature range	-30 °C to +70 °C
Relative humidity	80% maximum without condensation
Protection code	IP 20
Certification	CE certified

Dimensions

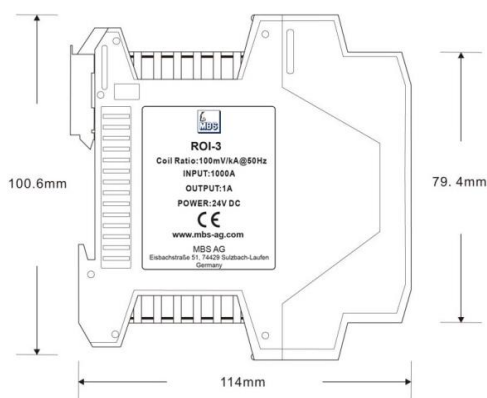

Figure 9: Dimensions of the ROI-3

Optional accessories

Power supply for DIN-rail mounting



Input:
85-264V AC
120-370V DC
Output:
20W
24V DC ($\pm 2\%$)

Item No.:
120-00003

Frequency transmission behaviour of the ROI-3

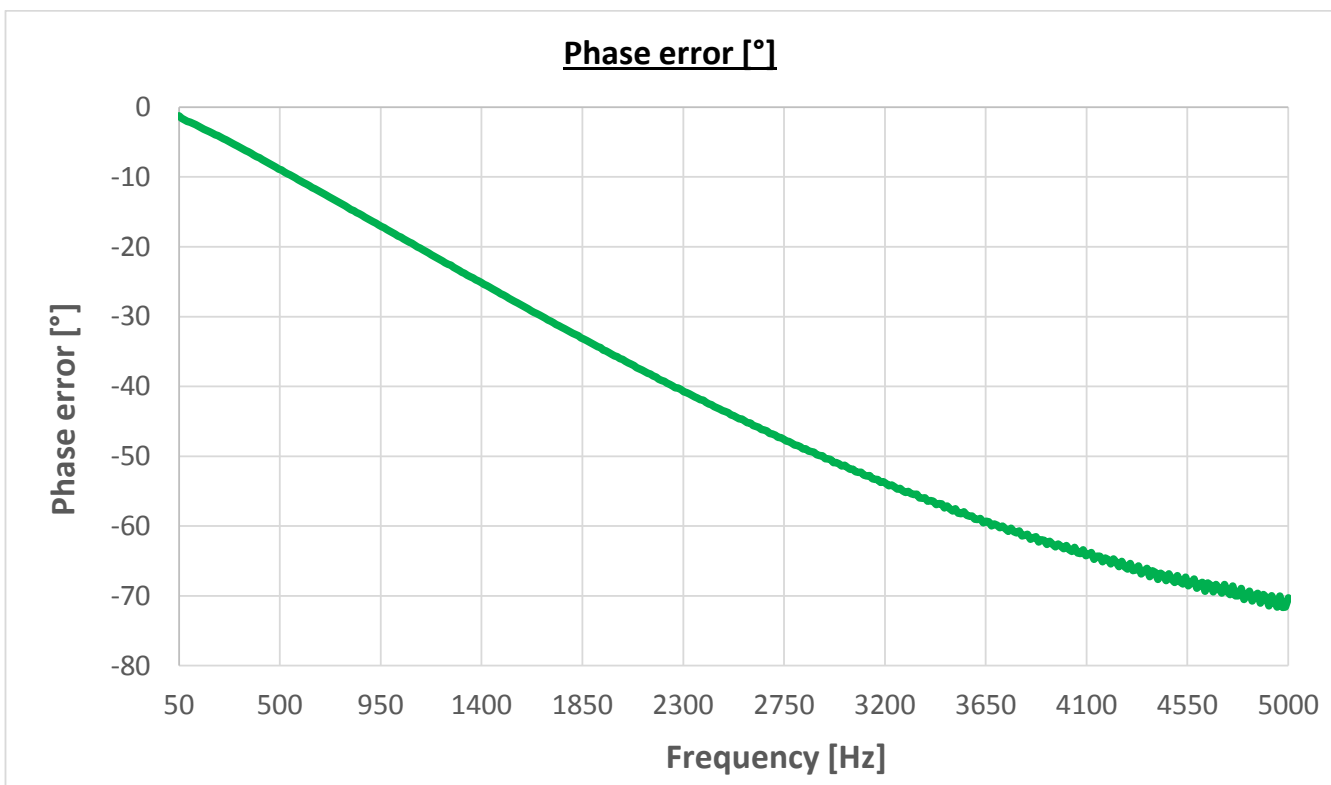
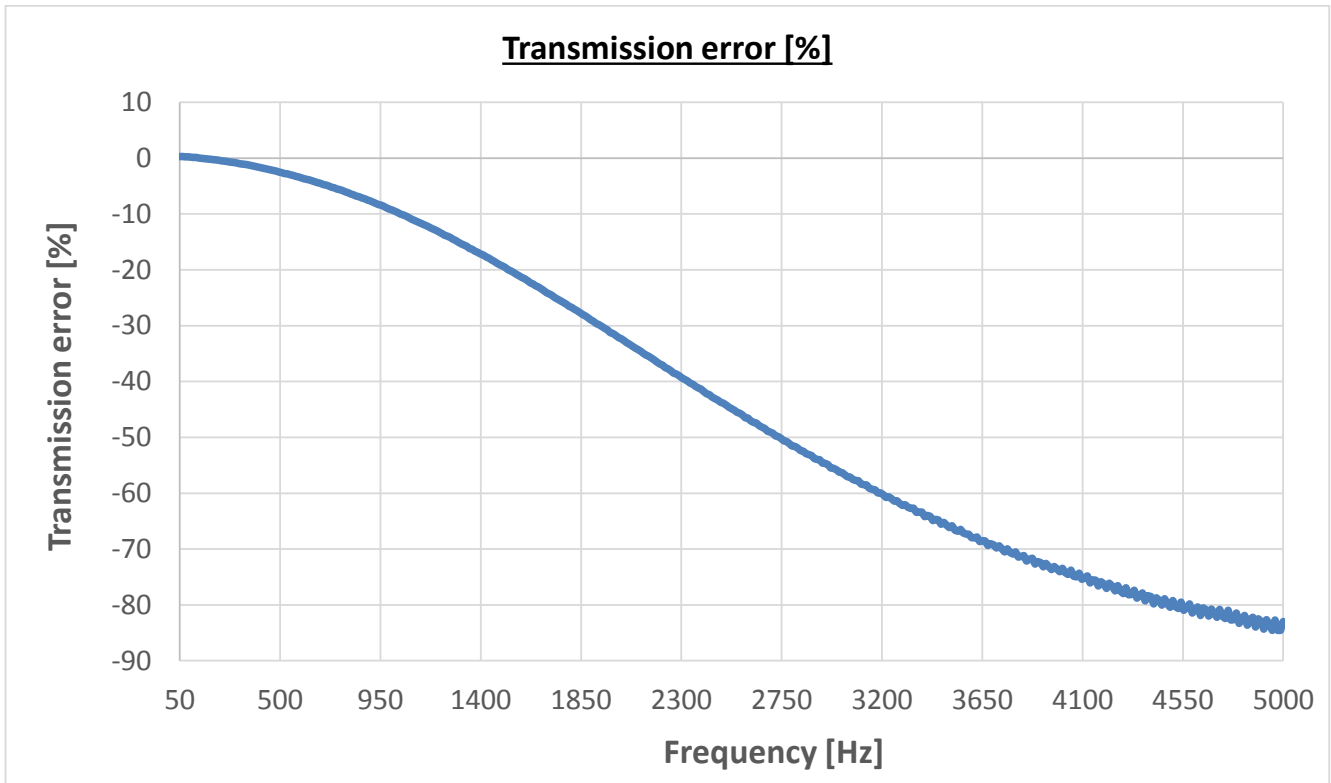

Figure 11: Frequency transmission behaviour of the ROI-3 with a FASK 150 (amplitude error and phase error)

Ordering table – Rogowski FASK coils and ROI-3 integrator

Product	Transmission ratio	Description	Ordering no.
FASK-100 (3 m)	100 mV / kA	FASK 100 100 mV/kA 3m	121-10001
FASK-100 (5 m)	100 mV / kA	FASK 100 100 mV/kA 5m	121-10002
FASK-100 (10m)	100 mV / kA	FASK 100 100 mV/kA 10m	121-10006
FASK-150 (3 m)	100 mV / kA	FASK 150 100 mV/kA 3m	121-10003
FASK-150 (10m)	100 mV / kA	FASK 150 100 mV/kA 10m	121-10007
FASK-200 (3 m)	100 mV / kA	FASK 200 100 mV/kA 3m	121-10004
FASK-200 (10m)	100 mV / kA	FASK 200 100 mV/kA 10m	121-10008
FASK-300 (3 m)	100 mV / kA	FASK 300 100 mV/kA 3m	121-10005
FASK-300 (10m)	100 mV / kA	FASK 300 100 mV/kA 10m	121-10009
ROI-3 (250 A)	250 / 1A	ROI 3 100 mV/kA 0.25kA	121-10101
ROI-3 (400 A)	400 / 1 A	ROI 3 100 mV/kA 0.4kA	121-10102
ROI-3 (630 A)	630 / 1 A	ROI 3 100 mV/kA 0.63kA	121-10103
ROI-3 (1 kA)	1000 / 1 A	ROI 3 100 mV/kA 1kA	121-10104
ROI-3 (1.5 kA)	1500 / 1 A	ROI 3 100 mV/kA 1.5kA	121-10105
ROI-3 (2 kA)	2000 / 1 A	ROI 3 100 mV/kA 2kA	121-10106
ROI-3 (4 kA)	4000 / 1 A	ROI 3 100 mV/kA 4kA	121-10107
ROI-3 (6 kA)	6000 / 1 A	ROI 3 100 mV/kA 6kA	121-10108
ROI-3 (10 kA)	10000 / 1 A	ROI 3 100 mV/kA 10kA	121-10109

Safety information

Read these instructions carefully in order to ensure safe operation of the Rogowski coil and/or of the integrator, and to be able to use all features and functions correctly. Safe operation can be ensured only if the Rogowski coil is used for its intended purpose within the intended range, and if the technical boundary conditions are complied with.

Important

Failure to comply with the warning information can result in severe injuries and/or material damage.

The current sensor must be installed and commissioned only by appropriately trained specialist personnel. The relevant national regulations must be complied with for the installation and operation of the current sensor. The current sensor must be used in compliance with the applicable standards and safety requirements, and with the operating instructions of the respective system and component manufacturer.

During operation of the sensor and/or the integrator, certain parts of the switching cabinet or the power distribution system (e.g. primary conductors) may be subject to dangerous voltage. The user must ensure that all necessary measures are taken to protect against an electric shock. The sensor and/or the integrator is a modular unit which contains live parts that must not be accessible after the installation. A protective casing or additional insulation barrier may be necessary. The main power supply must be disconnected during installation and maintenance, unless there are no dangerous live parts present in the system or in its immediate vicinity. In addition, the applicable national regulations must be complied with in every respect.

Safe and fault-free operation of this sensor and/or integrator can be ensured only if transport, storage, and installation are carried out correctly. The technical boundary conditions must not be breached during operation. Maintenance must be performed diligently.

Warning

Do not apply any mechanical forces (e.g. twisting, piercing, excessive pressure, severe bending, etc.) to the coil. These can have a serious negative effect on the accuracy of the device.

Operation and connection example

Connection example to a meter with 1 A current transformer inputs

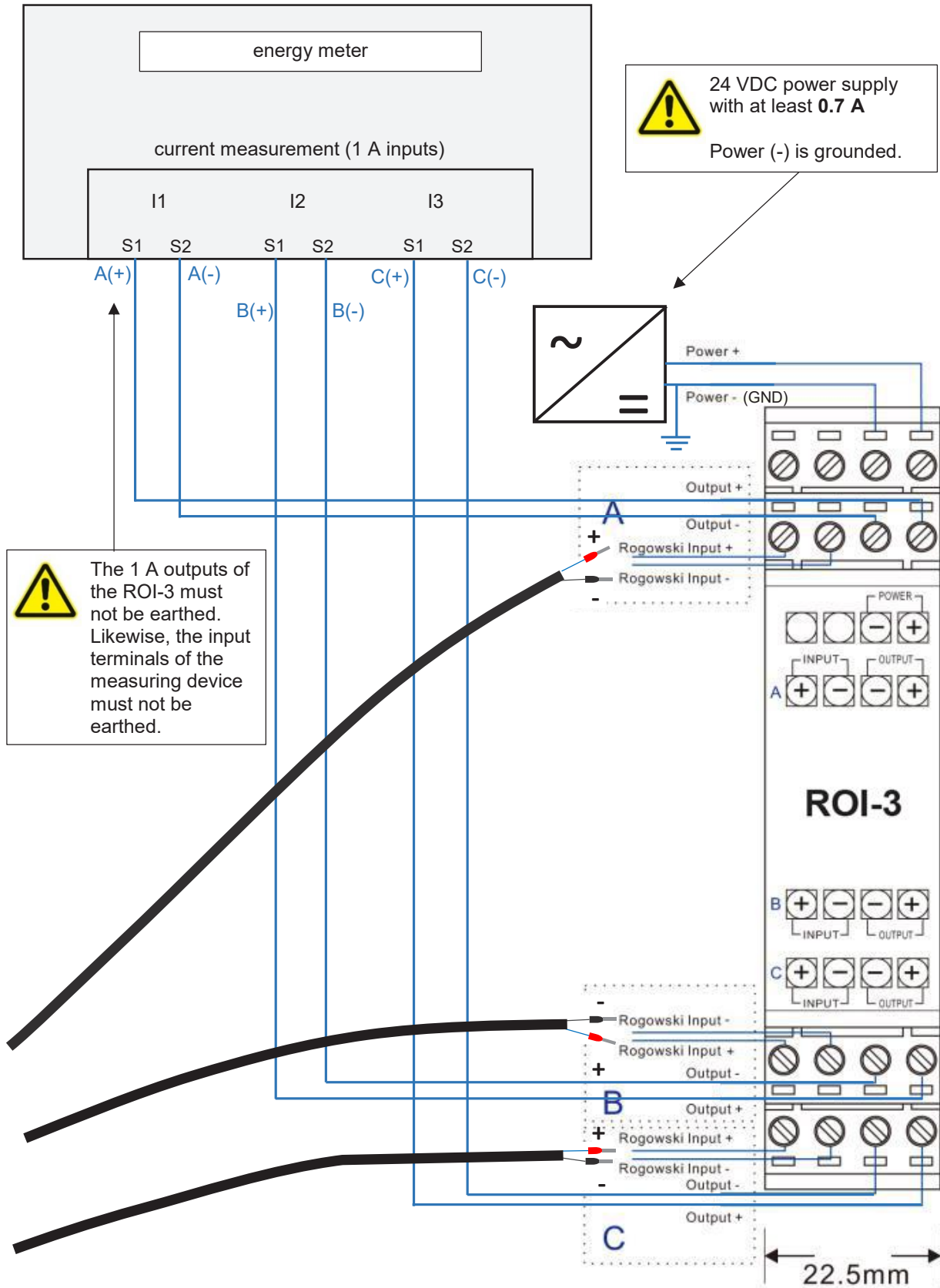

QE-485 - Universal converter with analogue and Modbus output



Application

The QE-485 universal current and voltage converter is the all-in-one solution for all your measurements, monitoring and analyses.

It enables the connection of Rogowski coils, current transformers, measuring transducers and all-current sensors (Hall sensors).

There is also the option to monitor temperature at the same time.

On the output side, the converter provides a freely configurable analogue output, a digital output and an RS485 Modbus RTU interface.

Features / Benefits

- ▶ Input for:
 - Rogowski coils
 - Current transformers with 5A or 1A secondary current
 - Voltage $\pm 10V_{pk}$ or $\pm 1V_{pk}$
 - Current transformers with 333mV secondary voltage
 - 20mA or 100mA AC/DC measuring transducers
 - $\pm 15V$ DC all-current sensors (Hall sensors)
- ▶ Additional temperature measurement (PT100 or NTC)
- ▶ Output: RS485 Modbus RTU
0...10V / 0...20 mA (freely configurable)
OptoMOS relays, max. 50mA; max. 30V DC
- ▶ Flexibel to use, thanks to simple configuration using free software (download via www.mbs-ag.com)
- ▶ Simple to attach to 35mm-DIN-rail
- ▶ Auxiliary voltage supply: 10...30V DC;
Internal consumption: max. 2.5VA

General technical specifications

- ▶ Working temperature range: $-10^{\circ}C \dots +60^{\circ}C$
- ▶ Storage temperature range: $-40^{\circ}C \dots +85^{\circ}C$
- ▶ Humidity: 10...90%, no condensation
- ▶ Permitted altitude for operation: $\leq 2000m$
- ▶ Protection class: IP20
- ▶ Sampling rate: 6400Hz @ 50Hz
- ▶ Accuracy of analogue output: 0.1%
- ▶ Baud rate: 1200...115,200 Baud (standard: 9600 Baud)
- ▶ Weight: approx. 55g

Accuracy

Input:	Crest factor	Measurement error	Temp. coefficient	Band-width
5A/1A (@ 5A)	4	50mA ... 250mA: $\pm 1\%$ 250mA ... 5A: $\pm 0.5\%$	$< 100ppm/^{\circ}C$	$> 2kHz$
20/100mA (@ 100mA)	4	1mA ... 5mA: $\pm 1\%$ 5mA ... 100mA: $\pm 0.5\%$	$< 100ppm/^{\circ}C$	$> 2kHz$
$\pm 1V_{pk}$	-	10mV ... 50mV: $\pm 1\%$ 50mV ... 1V: $\pm 0.5\%$	$< 100ppm/^{\circ}C$	$> 2kHz$
$\pm 10V_{pk}$	-	100mV ... 500mV: $\pm 1\%$ 500mV ... 10V: $\pm 0.5\%$	$< 100ppm/^{\circ}C$	$> 800Hz$

Connection overview

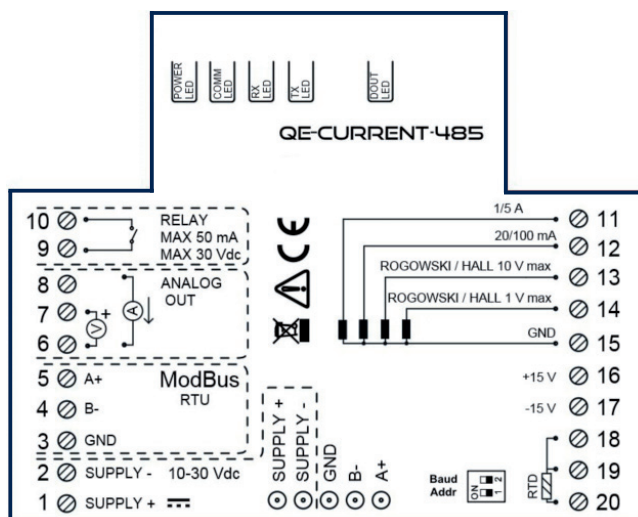

Ordering table / available measurement values

Art.-no.	I_{RMS}	max. I_{RMS}	min. I_{RMS}	\varnothing I_{RMS}	Ah (I_{RMS})	I_{DC}	max. I_{DC}	min. I_{DC}	\varnothing I_{DC}	Ah (I_{DC})	I_{AC}	max. I_{AC}	min. I_{AC}	\varnothing I_{AC}	Ah (I_{AC})	Hz	Crest factor	I_{peak}	THD	Temperature	Internal temperature	Measurement up to the 63rd harmonic	
120-00001	•	•	•	•	•	•	•	•	•	•	•	•	•	•	•	•	•	•	•	•	•	•	•
120-00002	•	•	•	•	•	•	•	•	•	•	•	•	•	•	•	•	•	•	•	•	•	•	•

Accessories

Product	Art.No.
Modbus-USB-stick	120-00100



Configuration options in the QE-485 universal converter software

ver. 0.0.

Actions

Modbus Global input settings Alarm settings Current Input Settings

Address 1

Delay 1

Baud rate 9600

FACTORY DEFAULT

HOME BACK NEXT QUIT

ver. 0.0.

Actions

Modbus Global input settings Alarm settings Current Input Settings

Ah saving Disabled

THD calculation Only AC components

Measurement type Float

Measurement channel Input 1A/5A

Temperature sensor PT100

3-Wire 3-Wire

Filtered measurement: Filter OFF

Output measurement retransmitted IRMS

Harmonic analysis Absolute

Output type Current 0-20 mA

Digital Output NORMALLY CLOSED

I start 0 A

Out start 4.000 uA

I Stop 5 A

Out Stop 20.000 uA

FACTORY DEFAULT

HOME BACK NEXT QUIT

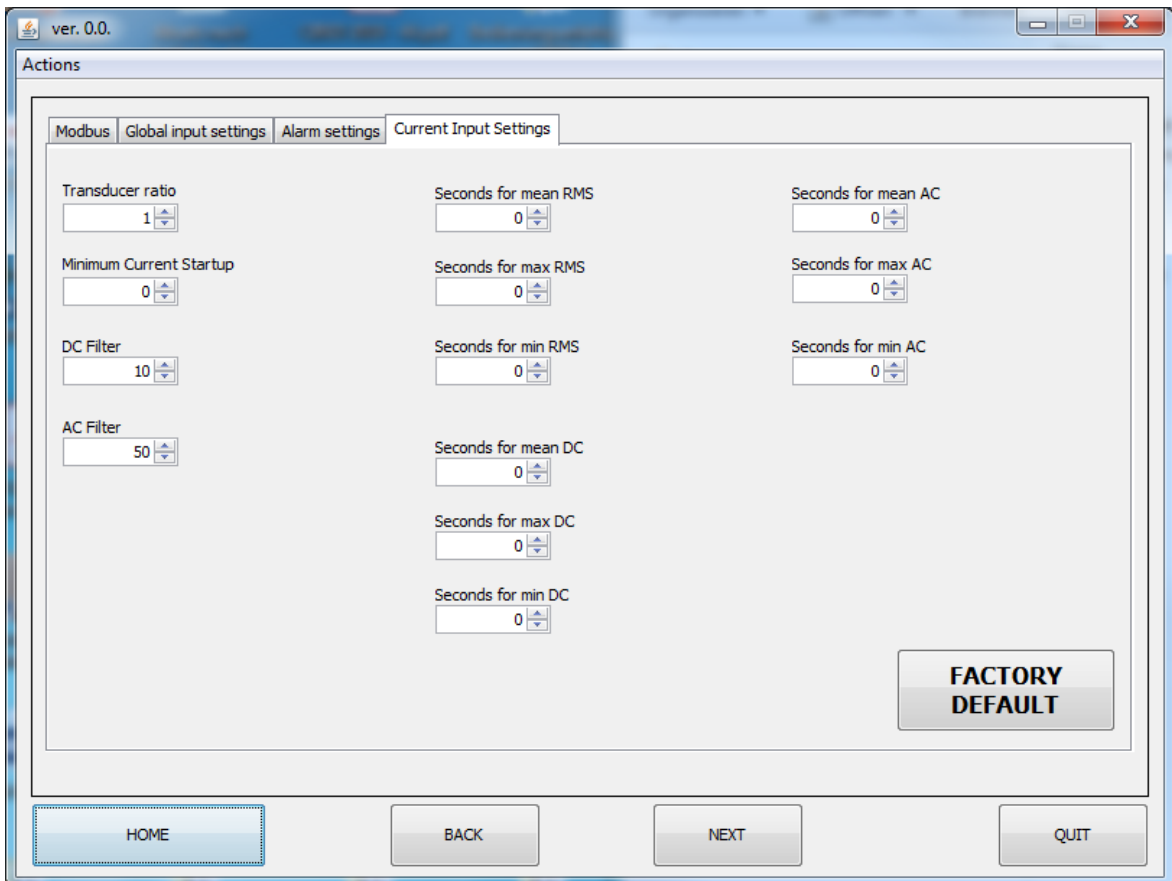
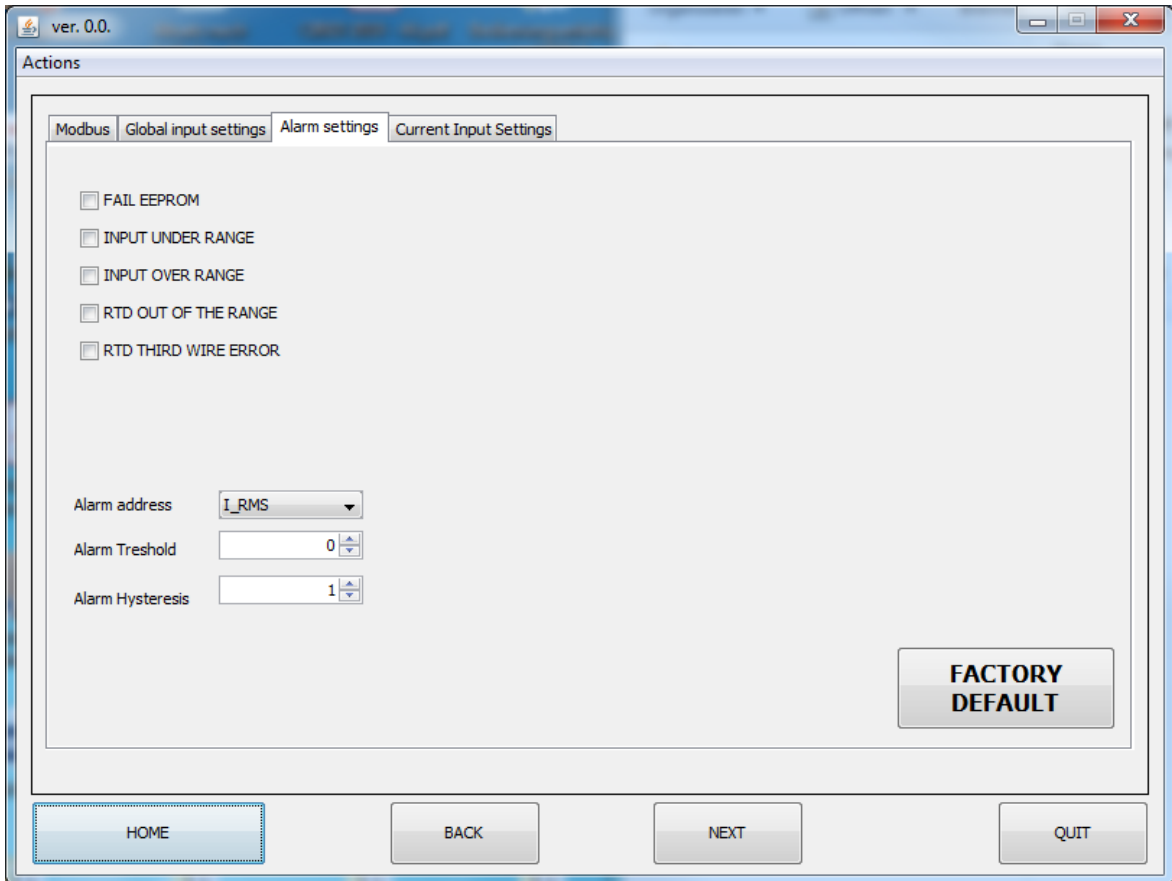

- Current transformers for industry
- Current transformers for tariffs
- Accessories for current transformers
- Medium-voltage transformers
- Bus bar insulators / -supports
- Shunts

- Voltage transformers
- All current sensors
- Measuring transducers
- Energy meters with or without MID approval
- Accessories for energy meters
- Panel board heaters, filter fans, roof fans and control units



www.mbs-ag.com

MBS AG
Eisbachstraße 51 74429 Sulzbach-Laufen Germany
Phone: +49 7976 9851-0 Telefax: +49 7976 9851-90
info@mbs-ag.com www.mbs-ag.com

